

TC3516-3MP

2/3" f=35mm F/1.6

3Megapixel Lens

● SPECIFICATIONS

MODEL NUMBER	TC3520-3MP	FILTER SIZE	M27 P=0.5
IMAGE FORMAT	2/3inch	DIMENSIONS	φ 29.5x40.8mm
FOCAL LENGTH	35mm	WEIGHT	65g
MAXIMUM APERTURE	F1:1.6	OPERATING TEMPERATURE	-20°C -+55°C
APERTURE RANGE	F1.6-16	MOUNT	C-mount
M.O.D.	0.35 m	FLANGE BACK	17.526mm
ANGLE OF VIEW (at 2/3inch)	HORIZONTAL	14.74°	BACK FOCUS 11.88mm
	VERTICAL	11.08°	

● DIMENSIONS

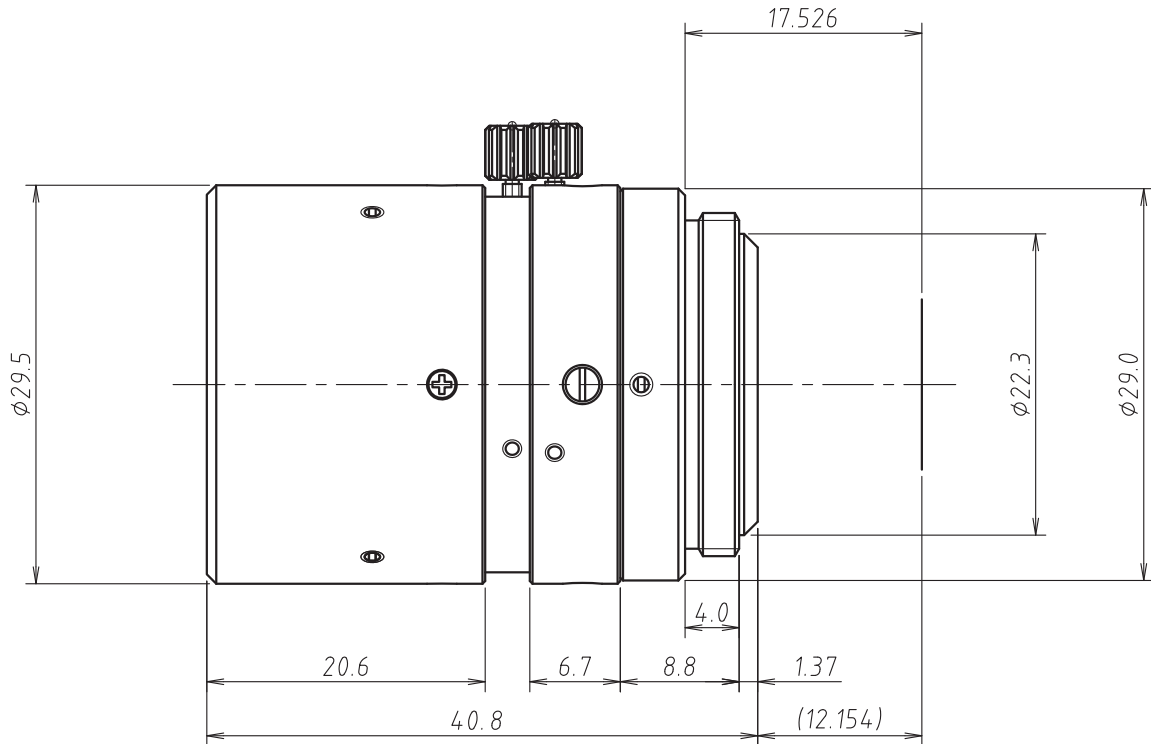

UNIT: mm